



RDSRF-232-T3FZ  
RS232 to RF User Configurable in 315 MHz  
User Manual  
Rev 1.0



**Reindeer Systems Pvt Ltd**

*Excellence Through Innovation*

B-1, "SHOBA", #26  
10<sup>th</sup> Avenue, Ashok Nagar,  
Chennai – 600083  
India.



## Document Revision History

Revision No.	Date	Description/Changes
V1.0	16/6/2008	Initial Release



## Table of Contents

<b>1 OVERVIEW .....</b>	<b>4</b>
<b>2 FEATURES .....</b>	<b>5</b>
<b>3 APPLICATIONS .....</b>	<b>5</b>
<b>4 CONNECTION DETAILS .....</b>	<b>6</b>
<b>5 RDSRF-232-T3FZ BOARD DIMENSIONS.....</b>	<b>7</b>
<b>6 THEORY OF OPERATION.....</b>	<b>8</b>
6.1 Receive Mode .....	8
6.2 Transmit mode.....	8
<b>7 DATA HANDLING IN RDSRF-232-T3FZ.....</b>	<b>8</b>
<b>8 TIME DELAY CALCULATIONS.....</b>	<b>9</b>
8.1 Example 1: .....	9
8.2 Example 2: .....	10
<b>9 USER CONFIGURATION MODE.....</b>	<b>11</b>
9.1 Mode Settings.....	11
9.2 Software.....	12
9.3 Procedure for using the user configuration mode.....	13
<b>10 TEST PROCEDURE FOR RDSRF-232-T3FZ .....</b>	<b>14</b>
<b>11 ELECTRICAL SPECIFICATIONS .....</b>	<b>15</b>
<b>12 ACCESSORIES .....</b>	<b>16</b>
<b>13 CONTACT US .....</b>	<b>17</b>
13.1 Technical Support .....	17
13.2 Sales Support.....	17



## 1 Overview

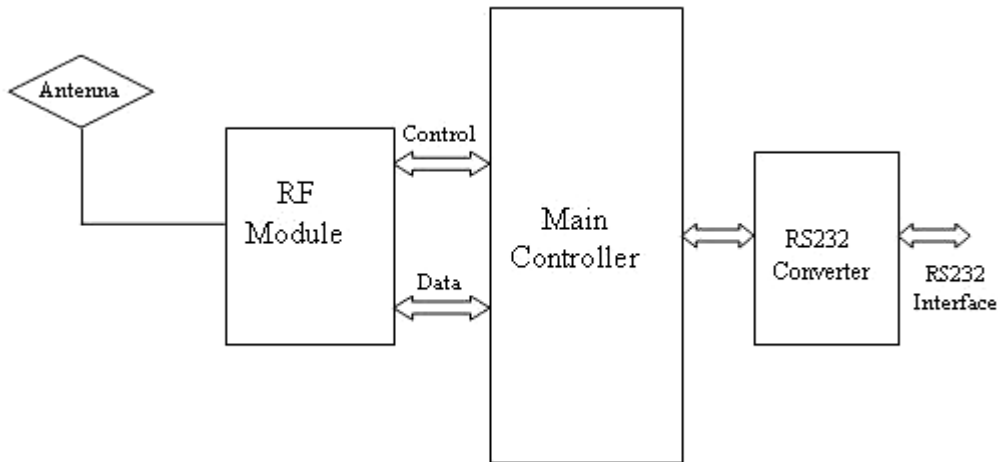

Figure 1: RDSRF-232-T3FZ Block Diagram

The RDSRF-232-T3FZ is single board high performance and low power serial to wireless solution. It is a complete plug and play system where the user can connect two boards and start a wireless communication between them instantaneously. The RDSRF-232-T3FZ can be integrated to existing systems without tedious software or hardware changes. These boards are intended to be used with systems which already have a RS232 interface. This device has a link budget of 120dB making it suitable for applications that require a robust communication from a range of 100 meters to 1000 meters line of sight.



## 2 Features

- Direct RS232 to RF converter with built-in level converter
- Transparent RS232 to antenna solution
- Wide input voltage from 5 to 28V DC
- Low Power Consumption
- Standard serial and RF baud rates from 1.4 Kbps to 115.2 Kbps possible
- Long range communication from 100 meters to 1000 meters line of sight
- Software based user configuration of frequency, serial and RF baud rate, out power, addressing etc (available in selected models only)
- RoHS compliant (on request)

## 3 Applications

- Direct RS232 wire replacement
- Industrial automation
- Crane control systems
- Textile instrumentation panels
- Instrumentation devices interface
- Digital weighing systems
- Wireless sensor networking
- Remote data logging
- Automated meter reading



## 4 Connection Details

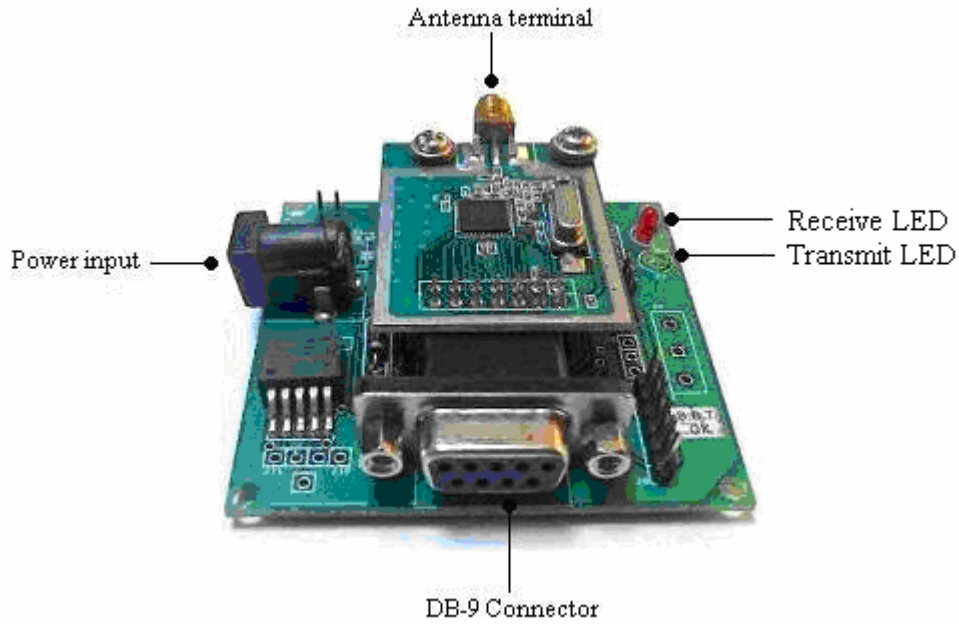
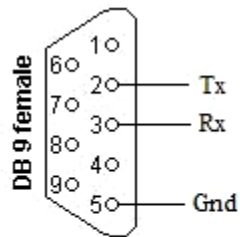

Figure 2: RDSRF-232-T3FZ connection diagram



Pins 1,4,6,7,8,9 are not connected

Figure 3: DB-9 pin out details



### 5 RDSRF-232-T3FZ board dimensions

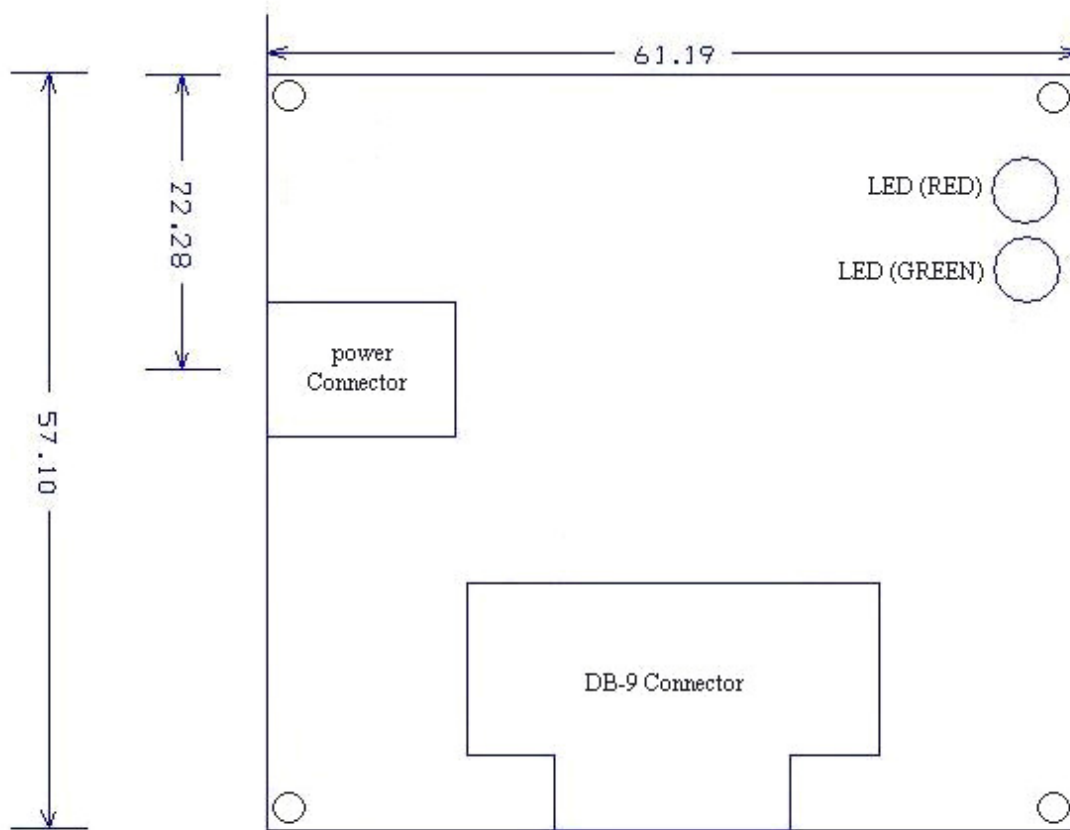

All dimensions are in mm

Figure 4: RDSRF-232-T3FZ board dimension



## 6 Theory of operation

The RDSRF-232-T3FZ operates in two different modes.

- 1) Receive Mode
- 2) Transmit Mode

### 6.1 Receive Mode

This is the default mode of operation after power on. In this mode the RF module will be in the listen mode, ready to receive data over the air and similarly the main controller will be in the wait mode to receive data either from the RF module or from the RS232.

When data is received from RF module the main controller will receive the data and will transfer it through the Tx line of the RS232 connector (ie. the DB-9 connector).

Upon successful reception of data, the Rx LED will blink to acknowledge the reception.

Alternatively if data is received from the RS232 the main controller will receive all the data and will switch the RF module to transmit mode. After this the data is sent over the air.

### 6.2 Transmit mode

The RDSRF-232-T3FZ will switch to transmit mode only if data is received by the main controller through the RS232 port. And after successful transmission of the entire data the Tx LED will blink and the RDSRF-232-T3FZ will switch back to receive mode automatically.

## 7 Data handling in RDSRF-232-T3FZ

The RDSRF-232-T3FZ can transmit or receive any kind of data whether it is in ASCII or hex or in any other format. It has the capability of handling even user defined protocols. The maximum packet size allowed is 1024 bytes per transmission. A small delay has to be present between two packets. This delay will depend on the serial, RF baud rates and also the packet size. The time delay calculation will be explained in detail in the following section.



## 8 Time Delay Calculations

As discussed in the previous section the maximum allowed packet size in RDSRF-232-T3FZ is 1024 bytes. And a time delay is required in between two packets.

### 8.1 Example 1:

The serial port settings are

Baud Rate	: 115200 bps
Parity	: None
Data Bits	: 8
Stop Bits	: 1

The RF settings are

Baud Rate	: 10000 bps
-----------	-------------

The time delay needed for a packet size of 255 bytes can be calculated as shown below

Packet size = 255 bytes  
Time taken by the main controller to receive the entire packet =  $((255 * 10)/115200)*2$ .  
= 0.044 Sec.

The time taken to transmit the entire packet =  $((9*8)/10000)*255$   
= 1.8 Sec.

Adding both the time we get a total time of

= 0.044+1.8  
= 1.844 Sec

Adding an extra buffer time of 360mS the total time delay between two packets of size 255 byte will be 2.2 Sec.



### 8.2 Example 2:

The serial port settings are

Baud Rate	: 115200 bps
Parity	: None
Data Bits	: 8
Stop Bits	: 1

The RF settings are

Baud Rate	: 250000 bps
-----------	--------------

The time delay needed for a packet size of 255 bytes can be calculated as shown below

Packet size = 255 bytes

$$\begin{aligned} \text{Time taken by the main controller to receive the entire packet} &= ((255 * 10)/115200)*2. \\ &= 0.044 \text{ Sec.} \end{aligned}$$

$$\begin{aligned} \text{The time taken to transmit the entire packet} &= ((9*8)/250000)*255 \\ &= 0.0734 \text{ Sec.} \end{aligned}$$

Adding both the time we get a total time of

$$\begin{aligned} &= 0.044+0.0734 \\ &= 0.117\text{mS} \end{aligned}$$

Adding an extra buffer time of 360mS the total time delay between two packets of size 255 byte will be 0.477 S

### 8.3 General Equation for calculating time delay:

In general the time delay between packets can be calculated using the below equation.

$$\text{Time delay between packets} = \text{Time 1} + \text{Time 2} + 0.360$$

Where

$$\text{Time 1} = (72/\text{RF Baud rate})*\text{Packet size in bytes.}$$

And

$$\text{Time 2} = 2*((\text{packet size in bytes}*10)/\text{serial baud rate})$$



## 9 User Configuration Mode

### 9.1 Mode Settings

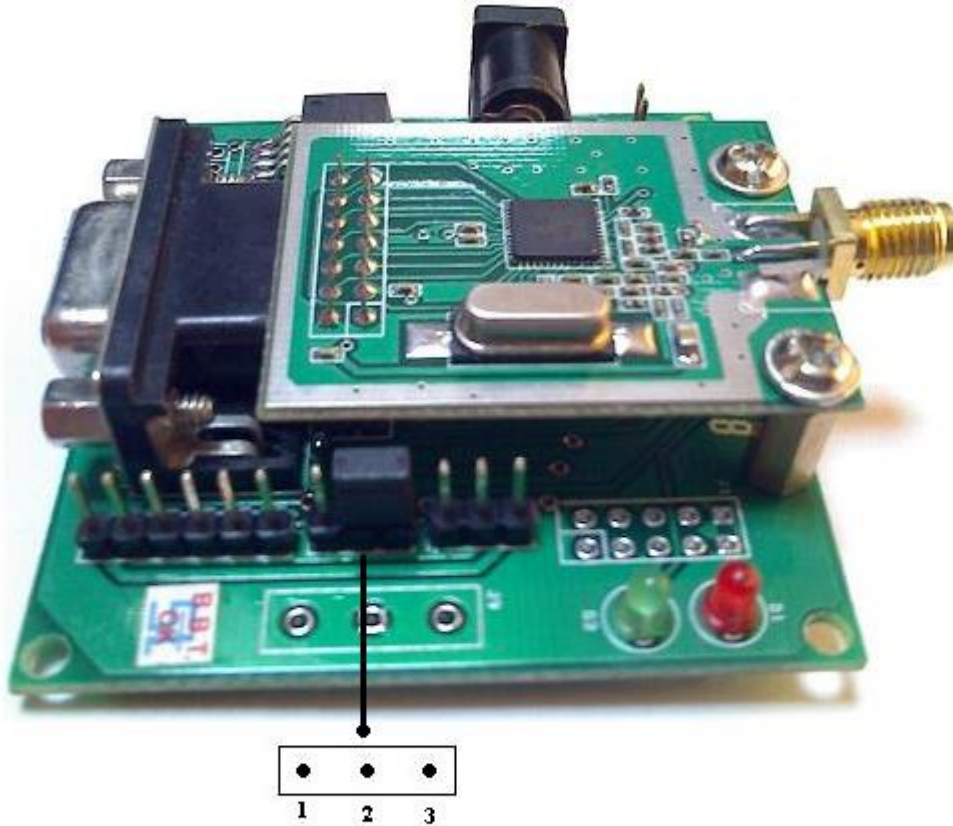

Normal Mode	Short Pins 1 and 2
Configuration Mode	Short pins 2 and 3



9.2 Software

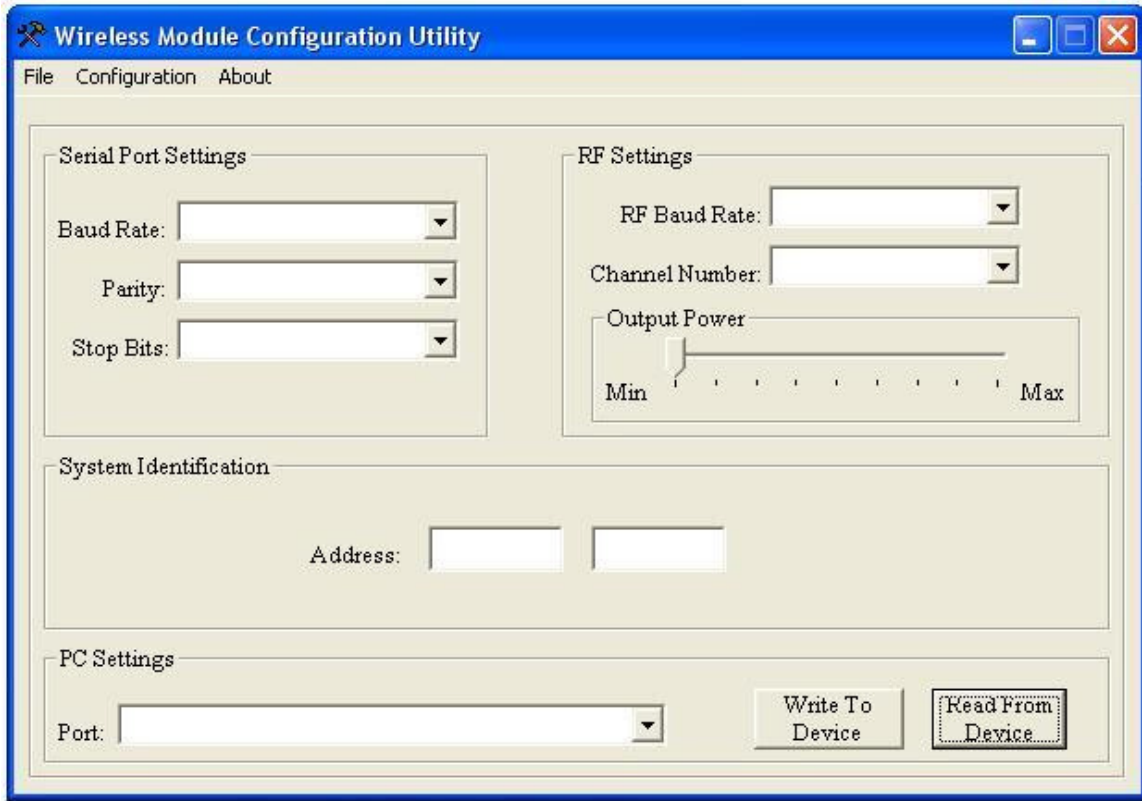

Figure2: Screenshot of Wireless Module Configuration Utility



### 9.3 Procedure for using the user configuration mode

- 1) Change the RDSRF-232-T8FZ-UC to configuration mode by shorting pins 2 and 3 as shown in figure1.
- 2) Power on the unit.
- 3) Run the software on a PC having a serial port.
- 4) Select all the settings as mentioned below.
  - a) Serial baud rate  
The Serial baud rate can be varied from 1.2 Kbps to 115.2 Kbps.
  - b) Serial parity  
The Parity can be set to either Even, Odd or None.
  - c) Serial stop bits  
The stop bits can be set to either 1 or 2
  - d) RF baud rate  
The RF baud rate can be set from 1.4 Kbps to 38.4 Kbps
  - e) RF channel  
The RF channel can be varied from channel 0 to channel 18
  - f) RF power output  
The RF output can be varied from -16 to +13 dBm.
  - g) Address  
This option can be used to set the address of the devices
  - h) COM port  
This option is used to select the PC COM port
- 5) Now use the “Write to Device” button to download the settings to the unit.
- 6) Upon successful download the message “Programming Successful” is displayed, in case of any error the message “Programming Not Successful Reset the device and try again” will appear. In case of error power off the unit and repeat from step1.
- 7) If the download is completed without any errors, power off the unit short pins 1 and 2 as shown in figure1 and then power it on again. Now the unit is ready to operate as per the user defined settings.
- 8) To read data that has been previously downloaded to the unit use the “Read from Device” button.
- 9) To load factory default settings click on the configuration tab and select “Load Defaults”. This will load all the default settings.
- 10) To save the settings click on the configuration tab and select “Save configuration” and follow the on screen messages. The configuration files are saved as “.ini” files.



- 11) To open any saved configuration file select the configuration tab and then select "Load Configuration". Now point to the configuration file that has to be loaded and follow the on screen messages.

Note:

Higher RF power output setting and lower RF baud rate setting will result in better communication range. More details on these settings are available in the software help file.

## 10 Test Procedure for RDSRF-232-T3FZ

Please follow the following steps for initial testing of the RDSRF-232-T3FZ

- Connect two units of RDSRF-232-T3FZ each to PC's serial port using a straight serial cable.

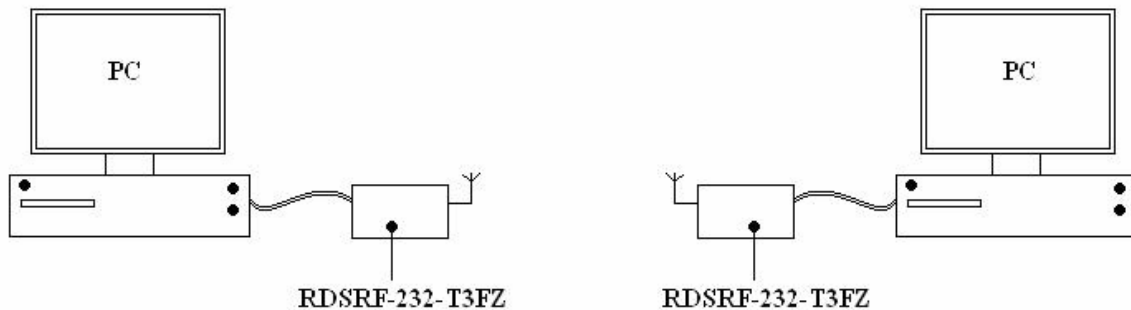

- Plug in the power supply with voltage anywhere between 5 to 40V DC in to the power connector on board.
- At power on both the Tx and Rx Led's will blink.
- Now open Hyper Terminal from the PC's start menu  
Select Start → programs → accessories → communications → Hyper Terminal
- In Hyper Terminal select the com port to which the RDSRF-232-T3FZ is connected and also set the serial baud rate, parity, data bits, stop bits and flow control to the values as indicated below

Baud Rate	: 9600 bps
Parity	: None
Data Bits	: 8
Stop Bits	: 1
Flow Control	: None



The above mentioned settings are the factory default settings which can be changed to any value upon user request or the user can change it to the required settings the option for which is available only in selected models

- Follow the above mentioned procedures to connect the second unit to the PC.
- Now key-in any data from one PC and the same will be reflected on the other PC.
- In turn the user can also send data with a maximum packet size of 1024 bytes using the send text file option in the Hyper Terminal.
- Similarly, data can be sent from the other side also.
  
- The two LED's indicated the successful transmission and reception of data.
- After successful transmission of data the Tx LED (Green) will blink and similarly upon successful reception the Rx LED (Red) will blink.

## 11 Electrical Specifications

Parameter	Min	Max	Units
VCC – Power Supply	5	28	V DC
Operating Temperature	-40	+85	°C
RF output power	-30	+10	dBm
Frequency of operation		315	MHz
Transmit Current consumption		33	mA
Receive current Consumption		27	mA



## 12 Accessories

The below mentioned accessories are available upon request. The cost of the product does not include these accessories.

### 1) Antenna

The antenna is mandatory for normal operation. The type of antenna can be selected from the wide ranges of antennae available in our website.

**Note: - The device should not be operated without antenna.**

### 2) Power Supply

Power adapters for the unit are available upon request.

### 3) Serial Cable

RS232 Serial cables are provided upon request

Note: - This product comes without a casing.



## **13 Contact Us**

### **13.1 Technical Support**

Reindeer Systems Pvt Ltd has built a solid technical support infrastructure so that you can get answers to your questions when you need them.

Our technical support engineers are available Mon-Fri between 9:30 am and 6:00 pm Indian standard time. The best way to reach a technical support engineer is to send an email to [support@reindeersystems.com](mailto:support@reindeersystems.com). E-mail support requests are given priority because we can handle them more efficiently than phone support requests.

### **13.2 Sales Support**

Our sales department can be reached via e-mail at [sales@reindeersystems.com](mailto:sales@reindeersystems.com) or by phone at 91-44-45022335/337.

Our sales department is available Mon-Fri between 9:30 am and 6:00 pm.



**Reindeer Systems Pvt Ltd**

*Excellence Through Innovation*

B-1, "SHOBA", #26  
10<sup>th</sup> Avenue, Ashok Nagar,  
Chennai – 600083  
India.

Phone: 91-44-45022335, 91-44-45022337

Fax: 91-44-45022336

Website: [www.reindeersystems.com](http://www.reindeersystems.com)