

RDSRF-485-T24FZ
RS485 to RF converter in 2.4 GHz
User Manual
Rev 1.0



Reindeer Systems Pvt Ltd

Excellence Through Innovation

B-1, "SHOBA", #26
10th Avenue, Ashok Nagar,
Chennai – 600083
India.



Document Revision History

Revision No.	Date	Description/Changes
V1.0	16/6/2008	Initial Release



Table of Contents

1 OVERVIEW	4
2 FEATURES	5
3 APPLICATIONS	5
4 CONNECTION DETAILS	6
5 RDSRF-485-T24FZ BOARD DIMENSIONS	7
6 THEORY OF OPERATION	8
6.1 Receive Mode	8
6.2 Transmit mode	8
7 DATA HANDLING IN RDSRF-485-T24FZ	8
8 TIME DELAY CALCULATIONS	9
8.1 Example 1:	9
8.2 Example 2:	10
8.3 General Equation for calculating time delay:	10
9 TEST PROCEDURE FOR RDSRF-485-T24FZ	11
10 ELECTRICAL SPECIFICATIONS	12
11 ACCESSORIES	13
12 CONTACT US	14
12.1 Technical Support	14
12.2 Sales Support	14



1 Overview

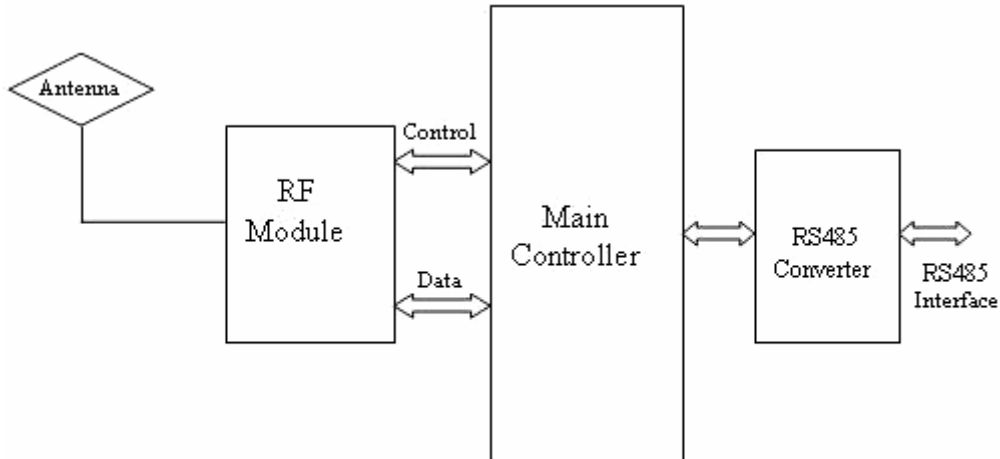

Figure 1: RDSRF-485-T24FZ Block Diagram

The RDSRF-485-T24FZ is single board high performance and low power serial to wireless solution. It is a complete plug and play system where the user can connect two boards and start a wireless communication between them instantaneously. The RDSRF-485-T24FZ can be integrated to existing systems without tedious software or hardware changes. These boards are intended to be used with systems which already have a RS232 interface.



2 Features

- Direct RS485 to RF converter with built-in level converter
- Transparent RS485 to antenna solution
- Wide input voltage from 5 to 40V DC
- Low Power Consumption
- Standard serial and RF baud rates from 1.4 Kbps to 115.2 Kbps possible
- Communication range from 15 meters to 50 meters line of sight
- Software based user configuration of frequency, serial and RF baud rate, out power, addressing etc (available in selected models only)
- RoHS compliant (on request)

3 Applications

- Direct RS485 wire replacement
- Industrial automation
- Crane control systems
- Textile instrumentation panels
- Instrumentation devices interface
- Digital weighing systems
- Wireless sensor networking
- Remote data logging
- Automated meter reading



4 Connection Details

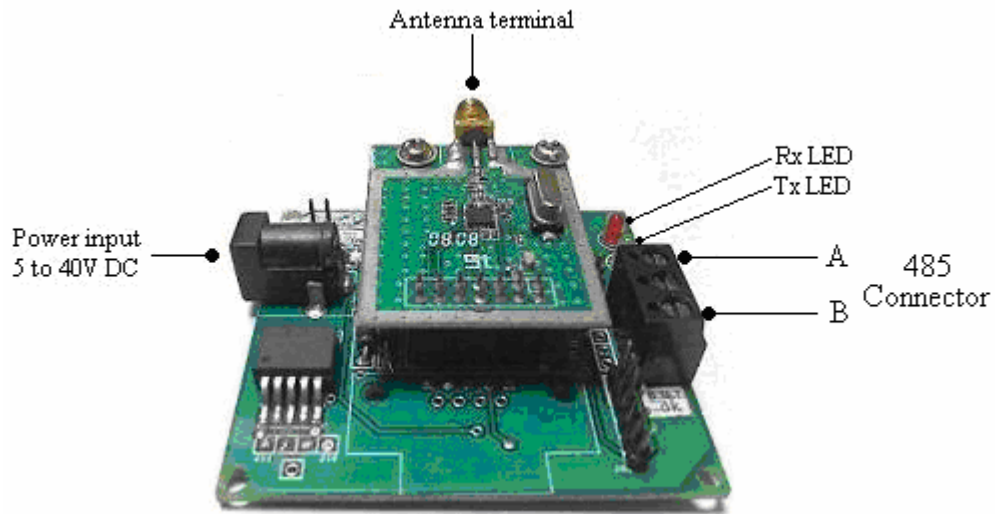
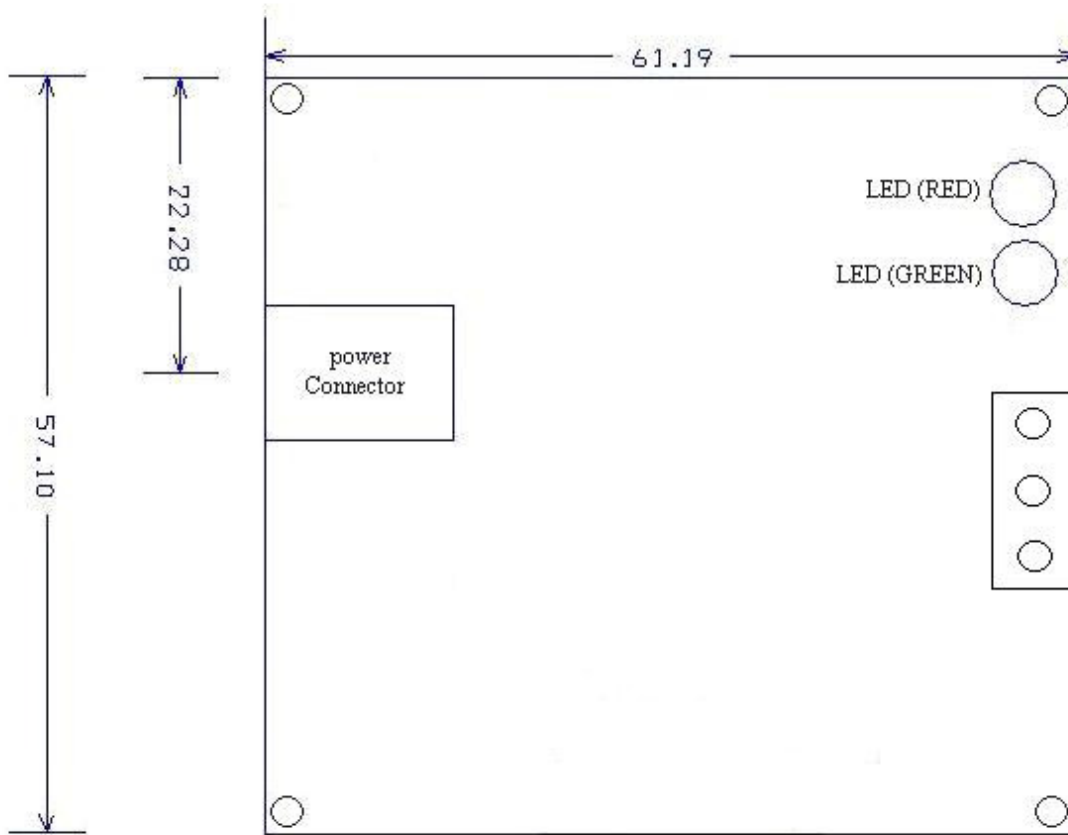

Figure 2: RDSRF-485-T24FZ connection diagram



5 RDSRF-485-T24FZ board dimensions



All dimensions are in mm

Figure 4: RDSRF-485-T24FZ board dimension



6 Theory of operation

The RDSRF-485-T24FZ operates in two different modes.

- 1) Receive Mode
- 2) Transmit Mode

6.1 Receive Mode

This is the default mode of operation after power on. In this mode the RF module will be in the listen mode, ready to receive data over the air and similarly the main controller will be in the wait mode to receive data either from the RF module or from the RS485.

When data is received from RF module the main controller will receive the data and will transfer it through the Tx line of the RS485 connector.

Upon successful reception of data, the Rx LED will blink to acknowledge the reception.

Alternatively if data is received from the RS485 the main controller will receive all the data and will switch the RF module to transmit mode. After this the data is sent over the air.

6.2 Transmit mode

The RDSRF-485-T24FZ will switch to transmit mode only if data is received by the main controller through the RS485 port. And after successful transmission of the entire data the Tx LED will blink and the RDSRF-485-T24FZ will switch back to receive mode automatically.

7 Data handling in RDSRF-485-T24FZ

The RDSRF-485-T24FZ can transmit or receive any kind of data whether it is in ASCII or hex or in any other format. It has the capability of handling even user defined protocols. The maximum packet size allowed is 1024 bytes per transmission. A small delay has to be present between two packets. This delay will depend on the serial, RF baud rates and also the packet size. The time delay calculation will be explained in detail in the following section.



8 Time Delay Calculations

As discussed in the previous section the maximum allowed packet size in RDSRF-485-T24FZ is 1024 bytes. And a time delay is required in between two packets.

8.1 Example 1:

The serial port settings are

Baud Rate	: 9600 bps
Parity	: None
Data Bits	: 8
Stop Bits	: 1

The RF settings are

Baud Rate	: 9600 bps
-----------	------------

The time delay needed for a packet size of 1024 bytes can be calculated as shown below

Packet size = 1024 bytes

Time taken by the main controller to receive the entire packet = $(1024 * 10)/9600$.
= 1.066 Sec.

The time taken to transmit the entire packet = $((1024+1024+5)*8)/9600$
= 1.711 Sec.

Adding both the time we get a total time of

= 1.066+1.711
= 2.77 Sec

Adding an extra buffer time of 10% the total time delay between two packets of size 1024 byte will be 3 Sec.



8.2 Example 2:

The serial port settings are

Baud Rate	: 9600 bps
Parity	: None
Data Bits	: 8
Stop Bits	: 1

The RF settings are

Baud Rate	: 9600 bps
-----------	------------

The time delay needed for a packet size of 255 bytes can be calculated as shown below

Packet size = 255 bytes

Time taken by the main controller to receive the entire packet = $(255 * 10)/9600$.
= 0.266 Sec.

The time taken to transmit the entire packet = $((255+255+5)*8)/9600$
= 0.429 Sec.

Adding both the time we get a total time of

= 0.266+0.429
= 0.695 Sec or 695 ms.

Adding an extra buffer time of 10%, the total time delay between two packets of size 1024 byte will be 0.760 Sec or 760 ms.

8.3 General Equation for calculating time delay:

In general the time delay between packets can be calculated using the below equation.

Time delay between packets = Time 1 + Time 2 + (10% of (Time 1 + Time 2))

Where

Time 1 = (No. of bytes * 10) / serial baud rate

And

Time 2 = $((2 * \text{No. of bytes}) + 5) * 8 / \text{RF Baud rate}$



9 Test Procedure for RDSRF-485-T24FZ

Please follow the following steps for initial testing of the RDSRF-485-T24FZ

- Connect two units of RDSRF-485-T24FZ each to PC's serial port using a RS485 to RS232 converter and a straight serial cable.

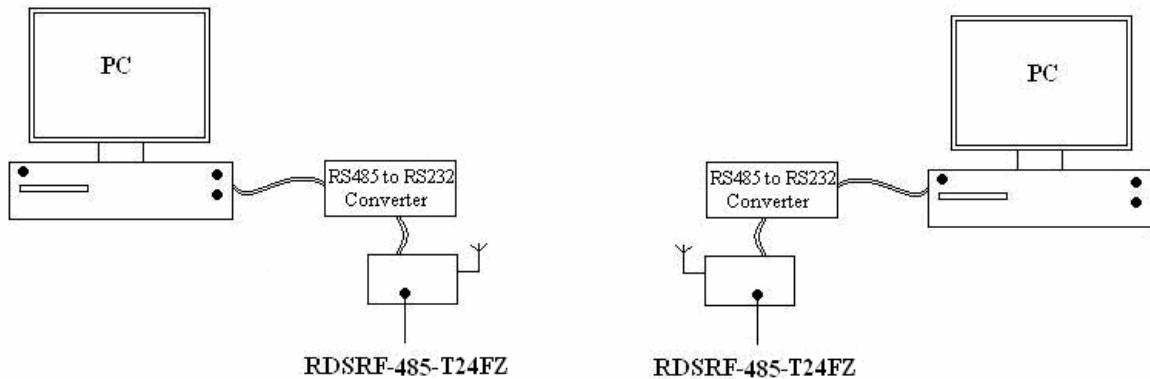

- Plug in the power supply with voltage anywhere between 5 to 40V DC in to the power connector on board.
- At power on both the Tx and Rx Led's will blink.
- Now open Hyper Terminal from the PC's start menu
Select Start → programs → accessories → communications → Hyper Terminal
- In Hyper Terminal select the com port to which the RDSRF-485-T24FZ is connected and also set the serial baud rate, parity, data bits, stop bits and flow control to the values as indicated below

Baud Rate	: 9600 bps
Parity	: None
Data Bits	: 8
Stop Bits	: 1
Flow Control	: None

The above mentioned settings are the factory default settings which can be changed to any value upon user request or the user can change it to the required settings the option for which is available only in selected models

- Follow the above mentioned procedures to connect the second unit to the PC.
- Now key-in any data from one PC and the same will be reflected on the other PC.



- In turn the user can also send data with a maximum packet size of 1024 bytes using the send text file option in the Hyper Terminal.
- Similarly, data can be sent from the other side also.

- The two LED's indicated the successful transmission and reception of data.
- After successful transmission of data the Tx LED (Green) will blink and similarly upon successful reception the Rx LED (Red) will blink.

10 Electrical Specifications

Parameter	Min	Max	Units
VCC – Power Supply	5	40	V DC
Operating Temperature	-40	+85	°C
RF output power		+1	dBm
Frequency of operation		2.4	GHz
Transmit Current consumption		50	mA
Receive current Consumption		90	mA



11 Accessories

The below mentioned accessories are available upon request. The cost of the product does not include these accessories.

1) Antenna

The antenna is mandatory for normal operation. The type of antenna can be selected from the wide ranges of antennae available in our website.

Note: - The device should not be operated without antenna.

2) Power Supply

Power adapters for the unit are available upon request.

Note: - This product comes without a casing.



12 Contact Us

12.1 Technical Support

Reindeer Systems Pvt Ltd has built a solid technical support infrastructure so that you can get answers to your questions when you need them.

Our technical support engineers are available Mon-Fri between 9:30 am and 6:00 pm Indian standard time. The best way to reach a technical support engineer is to send an email to support@reindeersystems.com. E-mail support requests are given priority because we can handle them more efficiently than phone support requests.

12.2 Sales Support

Our sales department can be reached via e-mail at sales@reindeersystems.com or by phone at 91-44-45022335/337.

Our sales department is available Mon-Fri between 9:30 am and 6:00 pm.



Reindeer Systems Pvt Ltd

Excellence Through Innovation

B-1, "SHOBA", #26
10th Avenue, Ashok Nagar,
Chennai – 600083
India.

Phone: 91-44-45022335, 91-44-45022337

Fax: 91-44-45022336

Website: www.reindeersystems.com